

# cannondale

## Installation Instructions (EN)

### Cannondale Wheel Sensor

#### Specifications

Intended Use	Bicycle only
Part Number	<b>CP1500U100S</b> - Cannondale Wheel Sensor <b>CP1400U100S</b> - Wheel Sensor Mounting Adapters
Compatibility	See page 3. Some wheels are not compatible with the Cannondale Wheel Sensor. Please consult your Cannondale Dealer to answer any questions regarding compatibility.
Battery type	User-replaceable CR2032, 3V
Battery life	Approximately 12 mo. at 1 hr./day
Operating temperature range	From -20° to 60°C (from -4°F to 140°F)
Wireless frequency/protocol	2.4GHz @ 0 dBm nominal
Water rating	1 ATM*
*The device withstands pressure equivalent to a depth of 10 m. For more information, go to <a href="http://www.garmin.com/waterrating">www.garmin.com/waterrating</a> .	

#### Observe These Sensor Installation Points

- The Wheel Sensor utilizes a two part Mounting Adapter system to mount to different hub/wheel types. See page 3 **Mounting Adapter Compatibility**. Adapter identification marks are molded into the Rubber Adapter Mount and Adapter Clamp.
- Use of unspecified adapter combinations could result in damage to the Wheel Sensor and/or to the wheel or in dislocation of the Wheel Sensor.
- Sensor must be mounted vertically against the inside of the spokes on the non-drive side of the front wheel and have contact with two spokes. However, when riding indoors, the sensor can be moved to the non-drive side of the rear wheel using the 0A adapter. This may result in the sensor being slightly tilted, which will not affect its function. Mounting the sensor in any other orientation will result in a less-accurate reading of speed and distance.
- Position the Wheel Sensor and secure as close to the hub axle as possible with the curved bottom surface matching the hub's radius.

See **CORRECT, INCORRECT**.

#### Required Tools:

Safety Eye Glasses, Shop Work Gloves, Hex Key: 2 mm, Torque Wrench

#### Parts Identification

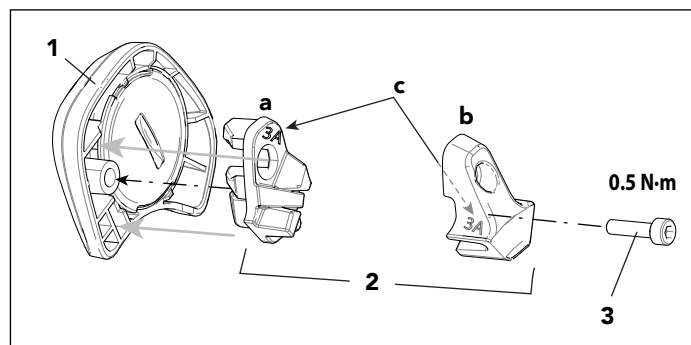

- |                     |                                |
|---------------------|--------------------------------|
| 1. Wheel Sensor     | a. Adapter Mount               |
| 2. Mounting Adapter | b. Adapter Clamp               |
| 3. Adapter Bolt     | c. Adapter Identification Mark |

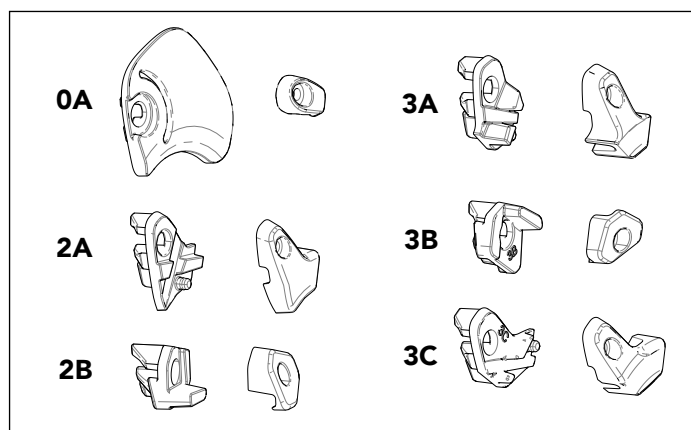

#### Important Warnings

##### **WARNING**

**In addition to these instructions:** You must read also the "Garmin Important Safety and Product Information" guide in the product box for product warnings and other important information.

**Intended Use:** For bicycle use only. Using this product the wrong way is dangerous.

**Compatibility:** Follow the instructions for attachment of the unit to compatible wheel hubs. Do not modify the sensor or the wheel in any way. If you encounter a problem, ask your Authorized Cannondale Dealer for help.

**Pre-Ride Inspection:** Before every ride on your bicycle: Make sure the accessory is mounted securely and in good condition. Remove and/or replace the accessory immediately if it becomes damaged.

**Cleaning:** Never use solvents, spray oils, or chemical spray cleaners to clean the accessory. Do not pressure wash.

**Eye, Hand Protection:** Wear safety eye glasses. Brake disc and wheel surfaces can cause injury to hands.

**Choking Hazard:** Keep batteries and small parts away and out of the reach of small children and babies. Dispose of batteries properly.

**YOU CAN BE SEVERELY INJURED, PARALYZED OR KILLED IN AN ACCIDENT IF YOU IGNORE THESE WARNINGS.**

## Installation

1. Insert Adapter Mount into Wheel Sensor body.
2. Position Spoke Clamp on wheel as specified in **Mounting Adapter Compatibility**. Page 3.
3. Place Wheel Sensor on the inside of the spokes and align the bolt hole of the Mounting Clamp with the bolt hole in the Wheel Sensor. Press and hold the two parts together.
4. Using a 2mm hex, tighten the Adapter Bolt to 0.5 Nm, while holding the Wheel Sensor firmly to prevent rotation.

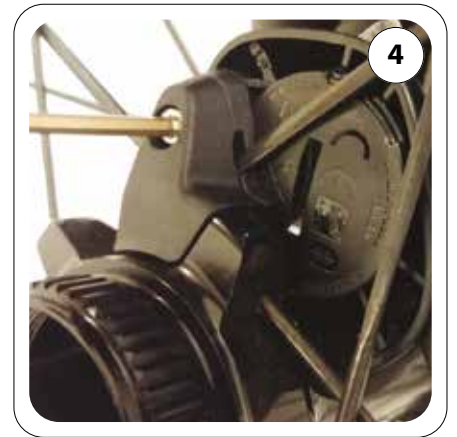

### CORRECT



Mount sensor on non-drive side.



Position sensor as close to the hub axis as possible.

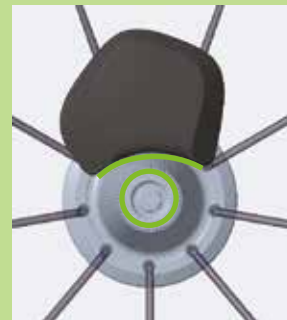

Align the bottom radius of the sensor to the hub axis.

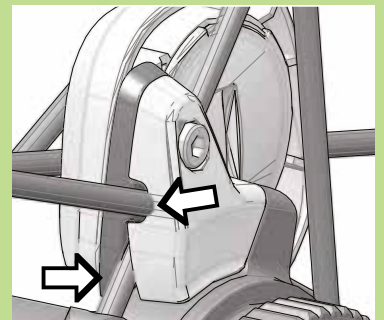

Make sure adapters close over spokes correctly.

### INCORRECT



Do not mount sensor on drive side.



Do not mount sensor far from hub axis.





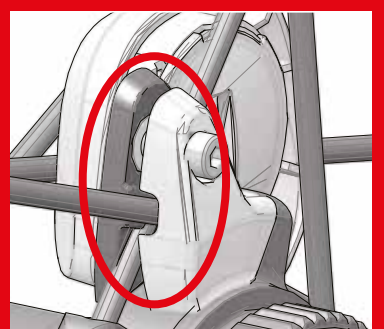









Do not mount sensor in other orientations relative to the hub.

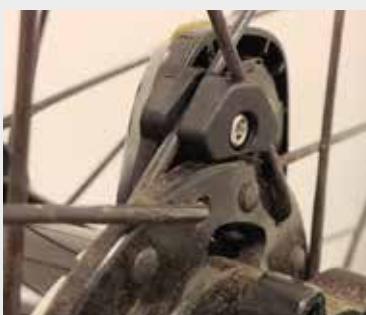

The plastic and rubber clamp parts must close completely. This is incorrect.

## Mounting Adapter Compatibility

Adapter	Use	Photo 1	Photo 2
<b>0A</b>	<p>For wheels not listed below. Must be secured around an inboard spoke with the sensor body contacting a second inboard spoke.</p> <p><b>NOTE:</b> Can be used to mount the Wheel Sensor to rear wheels for use on indoor trainers.</p> <p><b>NOTE:</b> Does not have Adapter Identification marks. Is the only Adapter Mount made of plastic and not rubber. 0A Spoke Clamp is the smallest of the Spoke Clamps.</p> <p><b>NOTE:</b> On straight pull hub/wheel combinations not listed use kit 0A if Mount Adapter 2B or 3B does not work.</p>		
<b>2A</b>	HollowGram KNØT hubs only		
<b>2B</b>	<p>2-cross lacing patterns with the trailing spoke on the <b>INSIDE</b> of the flange</p> <p><b>NOTE:</b> If Spoke Clamp does not fit the spoke angles, use Mounting Adapter 0A</p>		
<b>3A</b>	HollowGram 35 hubs, straight pull		
<b>3B</b>	<p>3-cross lacing patterns with trailing spoke on the <b>INSIDE</b> of the flange</p> <p><b>NOTE:</b> If Spoke Clamp does not fit between spoke cross and hub flange use Mounting Adapter 0A</p>		
<b>3C</b>	Straight pull, Lefty 60 hubs		



### Battery Replacement

See also "Garmin Important Safety and Product Information."

To check battery level spin the wheel two revolutions. If the LED (a) on the Wheel Sensor body flashes red the battery level is low.



1. Remove the Wheel Sensor from wheel using a 2mm hex.
2. Use a coin in the cover slot (b) and turn cover counter-clockwise until the cover dash (c) aligns with the unlock symbol (d) and is released.  
If necessary, carefully use a tiny thin blade screw driver placed under the lip of cover to lift it up. **Use only very light force to avoid damaging the cover, o-ring seal (e), or cover. Do not twist the screw driver.**
3. Remove the battery from the cover. Wait 30 seconds.
4. Insert the new battery (g) with the positive "+" symbol on the battery facing up. Note the "-" marking (h) in the cover, the battery's marking must face it. Note the small tabs (f); tilt the battery slightly under these tabs before pressing it in.
5. To reinstall in unit housing, align the cover dash (c) with the unlock symbol (d) and insert the cover with new battery.
6. Use the coin with light downward pressure and turn the battery door clockwise until the cover dash aligned with the as shown "LOCKED". Check the battery door to make sure it is flat against the housing and not tilted exposing or pinching the orange o-ring seal. Release the cover and re-try.

*NOTE: The LED (a) flashes red and green for a few seconds after battery replacement. When the LED flashes green and then stops flashing, the device is active and ready to send data.*

### Pairing the Wheel Sensor with your Garmin or other ANT+ or Bluetooth Device

The first time you connect a wireless sensor to your device using ANT+® or Bluetooth® technology, you must pair the device and sensor. After they are paired, the device connects to the sensor automatically when you start an activity and the sensor is active and within range.

*NOTE: The pairing instructions differ for each ANT+ or Bluetooth compatible device. See your owner's manual.*

- Bring the ANT+ or Bluetooth compatible device within 3 m (10 ft.) of the sensor.
- Stay 10 m (33 ft.) away from other wireless sensors while pairing.

After you pair the first time, your ANT+ or Bluetooth compatible device automatically recognizes the wireless sensor each time it is activated.

### Pairing Cannondale Wheel Sensor to the Cannondale App.

The Cannondale Wheel Sensor must be paired directly through the Cannondale App and not from your smartphone's Bluetooth settings.

1. From the app store on your smartphone, install and open the Cannondale App.
2. Bring your smartphone within 3m (10ft.) of the Wheel Sensor.  
*NOTE: Stay 10m (33ft.) way from other wireless sensors while pairing.*
3. While on the Pair a Sensor screen in the Cannondale App, spin the front wheel at least 2 rotations to wake Wheel Sensor. Wheel Sensor is awake when the LED in the battery door flashes green.
4. Continue to follow the instructions in the Cannondale App.

*NOTE: If pairing an additional wheel sensor to the Cannondale App either:*

*Add new bike to your Cannondale App Garage using a Wheel Sensor, by clicking "+Add Bike" from the Garage screen*

*or*

*Add a Wheel Sensor to an existing bike in your Cannondale App Garage by clicking "+Add Sensor" from the Bike Details screen. This can be useful if you have two wheel sets for one bike.*

### Translations

Please refer to [www.cannondale.com](http://www.cannondale.com) in your region for available language translations.

### Limited Warranty

The "components" terms apply to this accessory. For more information, go to the support area at [www.cannondale.com](http://www.cannondale.com).

#### NOTICE

Unauthorized service, maintenance, or repair parts can result in serious damage and void your warranty.

#### Contacting Cannondale

Go to [www.cannondale.com](http://www.cannondale.com) for contact information for your region.

### Other Information

© 2018 Garmin Ltd or its subsidiaries Garmin®, the Garmin logo, and ANT+® are trademarks of Garmin Ltd. or its subsidiaries, registered in the USA and other countries. Garmin Connect™ is a trademark of Garmin Ltd. or its subsidiaries. These trademarks may not be used without the express permission of Garmin.

The BLUETOOTH® word mark and logos are owned by the Bluetooth SIG, Inc and any use of such marks by Cannondale/Garmin are under license.

This product is ANT+® certified. Visit [www.thisisant.com/directory](http://www.thisisant.com/directory) for a list of compatible products and apps.

El número de registro COFETEL/IFETEL puede ser revisado en el manual a través de la siguiente página de internet.

